

# Scaleauto

Model Car Competition

2013 1/32  
1/24



**Race Tuned Slot Competition Cars**



# SRT VIPER GTS-R

SC-7055

ALMS Mid Ohio 2012 #93

• NEW •

SRT Motorsport Team VIPER



	Reference	Motor	Motor Size	Guide	Ratio	Chassis	Ball Bearing	Front		Rear	
								ø Tire	Hub	ø Tire	Hub
ALMS Mid Ohio 2012 #93	SC-7055	SC-26	 Long Can	SC-1622	12/44	SC-8000 R2	YES	26 x 10 Hard	23'5 x 10 Aluminium	27 x 13 Soft	23'5 x 13 Aluminium
White body racing kit	SC-7042										
Ready Painted Bodies											
SC-7055b ALMS Mid Ohio 2012 #93											

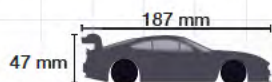



# LMS GT3



• NEW •

SC-7053

24h Nürburgring 2010 #49

Team Alexander Krebs



• NEW •

SC-7054

ADAC GT Master 2011 #7

Team Phoenix Racing

SC-7045  
ADAC Ruhr-Pokal-Rennen 2009 #80  
Team Phoenix Racing



	Reference	Motor	Motor Size	Guide	Ratio	Chassis	Ball Bearing	Front		Rear	
								ø Tire	Hub	ø Tire	Hub
24h Nürburgring 2009 #98	SC-7043	SC-26	Long Can	SC-1622	12/44	SC-8000 R2	YES	26 x 10 Hard	23'5 x 10 Aluminium	27 x 13 Soft	23'5 x 13 Aluminium
ADAC Ruhr-Pokal-Rennen 2009 #80	SC-7045										
24h Nürburgring 2010 #49	SC-7053										
ADAC GT masters 2011 #7	SC-7054										
White body racing kit	SC-7044										

Ready Painted Bodies	
SC-7043b	24h Nürburgring 2009 #98
SC-7045b	ADAC Ruhr-Pokal-Rennen 2009 #80
SC-7053b	24h Nürburgring 2010 #49
SC-7054b	ADAC GT masters 2011 #7

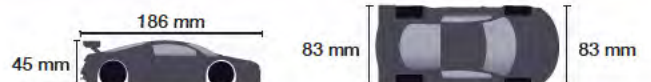



# BMW Z4 GT3

• NEW •

SC-7034

24h Dubai 2011 #17

Team Engstler



SC-7032

24h Barcelona 2011 #2

Schubert Motorsport



SC-7030

SuperGT 2011 #4

Studie AGs

	Reference	Motor	Motor Size	Guide	Ratio	Chassis	Ball Bearing	Front		Rear	
								ø Tire	Hub	ø Tire	Hub
SuperGT 2011 #4	SC-7030	SC-26	Long Can	SC-1622	12/44	SC-8000 R2	YES	26 x 10 Hard	23'5 x 10 Aluminium	27 x 13 Soft	23'5 x 13 Aluminium
24h Barcelona 2011 #2	SC-7032										
24h Dubai 2011 #1	SC-7034										
White body racing kit	SC-7031										

Ready Painted Bodies

SC-7030b SuperGT 2011 #4

SC-7032b 24h Barcelona 2011 #2

SC-7034b 24h Dubai 2011 #17

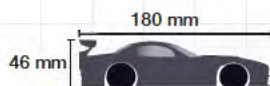



# Mercedes Benz SLS AMG GT 3



SC-7027

24h Nürburgring 2011 #3

Black Falcon

• NEW • SC-7028

ADAC GT Master 2011 #32

Gize-SLS Team



SC-7046 • NEW •

VLN Nürburgring 2011 #15

Mamerow Racing



SC-7024

IberGT Jarama 2011 #23

Vodafone BP Ultimate Team



	Reference	Motor	Motor Size	Guide	Ratio	Chassis	Ball Bearing	Front		Rear	
								ø Tire	Hub	ø Tire	Hub
IberGT Jarama 2011 #23	SC-7024	SC-26		SC-1622	12/44	SC-8000 R2	YES	26 x 10 Hard	23'5 x 10 Aluminium	27 x 13 Soft	23'5 x 13 Aluminium
24h Nürburgring 2011 #22	SC-7026										
24h Nürburgring 2011 #3	SC-7027										
ADAC GT Master 2011 #32	SC-7028										
White body racing kit	SC-7020	SC-25				SC-8000					
Ready Painted Bodies											
SC-7024b	IberGT Jarama 2011 #23										
SC-7026b	24h Nürburgring 2011 #22 Black Falcon										
SC-7027b	24h Nürburgring 2011 #3										
SC-7028b	ADAC GT Master 2011 #32 Gize SLS Team										

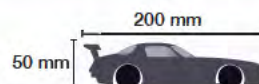



# BMW M3 GT2



SC-7035

24h LM 2011 #55  
BMW Motorsport

SC-7036

24h LM 2011 #56  
BMW Motorsport



• NEW •

SC-7037

ALMS 2010 #90  
Rahal Letterman Racing Team

SC-7022

24 h Nürburgring 2010 #25

Winner  
Team Schnitzer



	Reference	Motor	Motor Size	Guide	Ratio	Chassis	Ball Bearing	Front		Rear	
								ø Tire	Hub	ø Tire	Hub
24h LM 2010 #78	SC-7015	SC-25	Long Can	SC-1601	12/44	SC-8000	YES	26 x 10 Hard	23'5 x 10 Aluminium	27 x 13 Soft	23'5 x 13 Aluminium
24h Nürburgring 2010 #25	SC-7022	SC-26		SC-1622		SC-8000 R2					
24h LM 2011 #55	SC-7035										
24h LM 2011 #56	SC-7036										
ALMS 2010 #90	SC-7037	SC-25	SC-1601	SC-8000							
White body racing kit	SC-7009	SC-25									

Ready Painted Bodies

- SC-7008b 12h Sebring ALMS 2009 #92
- SC-7015b 24h LM 2010 #78
- SC-7022b 24h Nürburgring 2010 #25 •• new updated body ••
- SC-7035b 24h LM 2011 #55
- SC-7036b 24h LM 2011 #56
- SC-7037b ALMS 2010 #90 •• new updated body ••

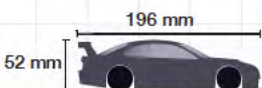



# Jaguar XKR GT2

**SC-7029 • NEW •**

**12h Sebring 2011 #099**

*Jaguar RSR*



**SC-7023**

**LM 2010 #81**

*Jaguar RSR*



	Reference	Motor	Motor Size	Guide	Ratio	Chassis	Ball Bearing	Front		Rear	
								ø Tire	Hub	ø Tire	Hub
24h LM 2010 #81	SC-7023	SC-26		SC-1601	12/44	SC-8000 R2	YES	26 x 10 Hard	23'5 x 10 Aluminium	27 x 13 Soft	23'5 x 13 Aluminium
12h Sebring ALMS 2011 #099	SC-7029					SC-8000					
White body racing kit	SC-7019	SC-25	Long Can								
Ready Painted Bodies											
	SC-7023b	24h LM 2010 #81									
	SC-7029b	12h Sebring ALMS 2011 #99									

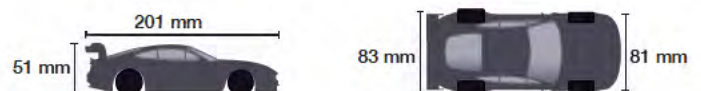



# Porsche 911 RSR

**SC-7040**  
**SuperGT 2011 #33**  
Team Hankook KTR



**NEW** SC-7041  
**24h Nürburgring 2011 #18**  
Manthey Racing



SC-7049 **NEW**  
**Super GT 2011 #25**  
Zent

	Reference	Motor	Motor Size	Guide	Ratio	Chassis	Ball Bearing	Front		Rear	
								ø Tire	Hub	ø Tire	Hub
SuperGT 2011 #33	SC-7040										
24h Nürburgring 2011 #18	SC-7041	SC-26		SC-1622	12/44	SC-8000 R2	YES	26 x 10 Hard	23'5 x 10 Aluminium	27 x 13 Soft	23'5 x 13 Aluminium
Super GT 2011 #25	SC-7049					SC-8000					
White body racing kit	SC-7005	SC-25		SC-1601							
Ready Painted Bodies											
SC-7038b	LM 2011 #80 Flying Lizard										
SC-7039b	LM 2011 #81 Flying Lizard										
SC-7040b	SuperGT 2011 #33										
SC-7041b	24h Nürburgring 2011 #18										
SC-7049b	SuperGT 2011 #25 Zent										

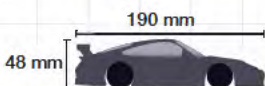



# Porsche 911 GT3



**SC-7033** • NEW •  
**IMSA 2011 GT3 Cup**  
**Road Atlanta #24**  
NGT Motorsport

**SC-7013**  
**IMSA GT3 Challenge 2008 #97**  
Kelly Moss Racing



# Porsche 911 GT3 Rally

**SC-7012**  
**Rally Vilajiosa 2009 #3**  
Fuster



	Reference	Motor	Motor Size	Guide	Ratio	Chassis	Ball Bearing	Front		Rear	
								ø Tire	Hub	ø Tire	Hub
Rally Vilajiosa 2009 #3	SC-7012	SC-25	Long Can	SC-1605	12/44	SC-8000	YES	26 x 10 Hard	23'5 x 10 Aluminium	27 x 13 Soft	23'5 x 13 Aluminium
GT3 Challenge 2008 #97	SC-7013	SC-26		SC-1622		SC-8000 R2					
IMSA 2011 GT3 Cup Road Atlanta #24	SC-7033			SC-1605		SC-8000					
White body racing kit	SC-7004	SC-25		SC-1601							

Ready Painted Bodies

SC-7012b Rally Vilajiosa 2009 #3

SC-7013b GT3 Challenge 2008 #97

SC-7033b IMSA 2011 GT3 Cup Road Atlanta #24

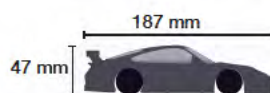
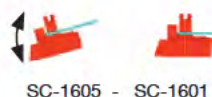





**SC-8000 RTR**  
Complete SC-8000 chassis assembled. Fixed guide



**SC-8000 RTR 3** **NEW**  
Complete SC-8000 chassis assembled  
Swing arm system. Pre 2012

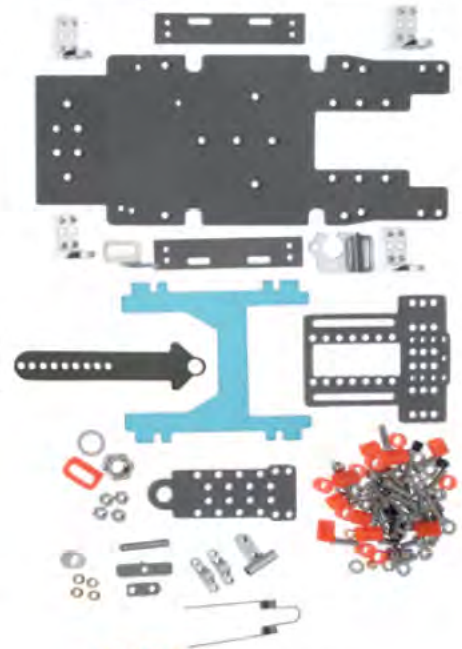

**SC-8000b**  
Complete chassis kit Pre-2012

**SC-8000 RTR 2** **NEW**  
Complete SC-8000 R2 chassis assembled. Fixed guide



**SC-8100**  
Chassis main plate

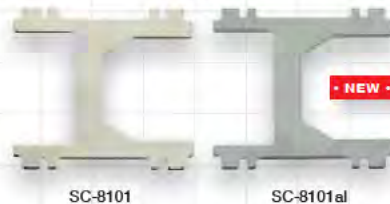

SC-8101 SC-8101al



SC-8107 SC-8116

Ref	Metal body mount
SC-8107	Body mount set
SC-8116	Motor mount stopper

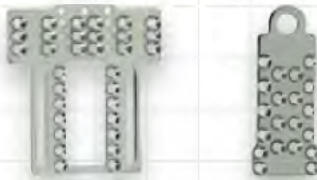

SC-8103 SC-8104

Ref	Guide holders
SC-8103	Front axle subframe (steel)
SC-8104	Fix Guide holder (steel)
SC-8104c	Fix guide holder (carbon fiber)

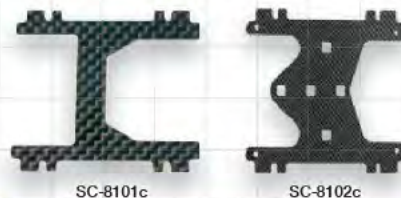

SC-8101c SC-8102c

Ref	Chassis Plates
SC-8101	H Plate (steel)
SC-8101c	H Plate (carbon fiber)
SC-8101al	H Plate (aluminium)
SC-8102c	H Plate Pro (carbon fiber)



for front and rear axle)

Axle holder		Axle holder with suspension	
Ref	Height	Ref	Height
SC-8108a	7 mm	SC-8109a	7 mm
SC-8108b	8 mm	SC-8109b	8 mm
SC-8108c	9 mm	SC-8109c	9 mm
SC-8108d	10 mm	SC-8109d	10 mm
SC-8108e	11 mm	SC-8109e	11 mm



SC-8121 SC-8106

Ref	Metal body mount
SC-8121	Rear axle mount self adjustable
SC-8106	Complete swing arm set for rally setup



SC-8111 SC-8113 SC-8122 SC-8120

Ref	Axle Spacers
SC-8111	Steel 3 mm axle spacers
SC-8112	Plastic 3 mm axle spacers
SC-8113	Body Spacers 2 mm
SC-8120	Body special allen fixing screw
SC-8122	Screwset <b>NEW</b>



SC-8114b SC-8114

Ref	Motor Mount
SC-8114	Motor mount
SC-8114b	Motor mount CNC <b>NEW</b>
SC-8115	Motor mount can fixing



Aluminium body suspension supports		
Reference	Height / Color	Sample
SC-8126a	2 mm • blue	
SC-8126b	3 mm • purple	
SC-8126c	4 mm • copper	
SC-8126d	5 mm • black	
SC-8126e	6 mm • red	



## Cockpits



**SC-7604**  
Modern RALLY complete cockpit



**SC-7605** • NEW •  
Modern GT complete cockpit

## Body Kits and Body Spare Pieces



Ref	Metal body mount
<b>SC-8117</b>	Porsche 911 GT3 RSR
<b>SC-8119</b>	BMW M3 GT2' Jaguar XKR GT2' Mercedes SLS AMG GT3
<b>SC-8124</b>	LMS GT3
<b>SC-8125</b>	BMW Z4 GT3 • NEW •



Reference	Body kits
<b>SC-7501</b>	Porsche 911 RSR (997 model)
<b>SC-7502</b>	Porsche 911 GT3 (997 model) Cup & Rally
<b>SC-7503</b>	BMW M3 GT2
<b>SC-7504</b>	Jaguar XKR GT2
<b>SC-7505</b>	Mercedes SLS AMG GT3
<b>SC-7506</b>	LMS GT3
<b>SC-7507</b>	BMW Z4 GT3 • NEW •
<b>SC-7508</b>	SRT VIPER GTS-R • NEW •

Reference	Body spare pieces
<b>SC-7611</b>	Porsche 911 GT3 (997 model) Cup & Rally
<b>SC-7612</b>	BMW M3 GT2
<b>SC-7613</b>	Jaguar XKR GT2
<b>SC-7614</b>	Mercedes SLS AMG GT3
<b>SC-7616</b>	LMS GT3
<b>SC-7617</b>	BMW Z4 GT3 • NEW •
<b>SC-7520</b>	SRT VIPER GTS-R • NEW •

## Top Performance Setup



Lightweight kit (Cockpit + Clear Windows)	Rear wing (Rubber + Carbon fiber)	Car Model
<b>SC-7901</b>	<b>SC-7901b</b>	Porsche 911 GT3 RSR
<b>SC-7902</b>	<b>SC-7902b</b>	BMW M3 GT2
<b>SC-7903</b>	<b>SC-7903b</b>	Jaguar XKR GT2
<b>SC-7904</b>	<b>SC-7904b</b>	Mercedes SLS AMG GT3
<b>SC-7905</b>	<b>SC-7905b</b>	LMS GT3
<b>SC-7906</b>	<b>SC-7906b</b>	BMW Z4 GT3 • NEW •
<b>SC-7908</b>	<b>SC-7908b</b>	SRT VIPER GTS-F • NEW •



### R+D Team »»» Improving Performance

Scaleauto's constant aim for technology improvement brings new materials and production systems which let us setting new heights in performance standards for the most demanding 'pro' racing community.





R+D Team >>> Leading Standards

### New standard for gear tooth identification

Scaleauto's gear range is ruled under the new Color Code that states a unique color to each gear depending on the amount of teeth.

Standardization makes tuning experience smoother for the serious Professional Slot Racer.

## NEW INTERNATIONAL COLOR CODE

Color	Gear teeth	Color	Gear teeth
	20 / 30 / 40		25 / 35 / 45
	21 / 31 / 41		26 / 36 / 46
	22 / 32 / 42		27 / 37 / 47
	23 / 33 / 43		28 / 38 / 48
	24 / 34 / 44		29 / 39 / 49

### In-line Procomp RS (3mm)



Ref	Color	Teeth	Ø
SC-1102		32	ø 17'25 mm
SC-1104		34	ø 18'35 mm
SC-1105		35	ø 18'9 mm
SC-1106		36	ø 19'5 mm
SC-1107		37	ø 20'0 mm
SC-1108		38	ø 20'5 mm

### AngleWinder Procomp RS-2 (3mm)



Ref	Color	Teeth	Ø
SC-1051b		39	20'5 mm
SC-1052b		40	21'0 mm
SC-1053b		41	21'5 mm
SC-1054b		42	22'0 mm
SC-1055b		43	22'5 mm
SC-1056b		44	23'0 mm
SC-1057b		45	23'5 mm

### Axle stopper (3mm)



Ref	Description
SC-1126	Axle stopper 3mm light and anodized. M3 screw

### Carbon fiber sheet



Reference	Description
SC-3500	Carbon fiber sheet 140 x 62 x 1mm
SC-3501	Carbon fiber sheet 140 x 100 x 1mm



**Guides**



**SC-1601**  
Pro Guide 3/16"  
Club  
8'5 mm blade



**SC-1624**  
Narrow Pro Guide 3/16"  
Club racing  
9'1 mm blade



**SC-1602**  
Pro Guide 3/16"  
Home  
7 mm blade



**SC-1626**  
Racing Pro guide 3/16"  
Club  
9'1 mm blade



**SC-1622**  
Heavy duty 3/16"  
Club Racing  
9'1 mm blade



**SC-1629** **NEW**  
Nylon nut with M2 pass for  
3/16 guide

**Guide accessories**



**SC-1615**  
Guide clips for SC-1601, SC-1602,  
SC-1622 & SC-1626



**SC-1614** Universal Soft braid 6 units  
**SC-1614b** Universal Soft braid 50 units  
**SC-1614c** Universal Soft braid. 100 units



**SC-1632** **NEW**  
Super slim braids with clips for 3/16  
guide sets SC-1601, 1602, 1622 and  
SC-1626



**SC-1615b** **NEW**  
Guide clips for Narrow guide  
(SC-1624)



**SC-1628** Narrow braids (6 units)  
**SC-1628b** Narrow braids (50 units)  
**SC-1628c** Narrow braids (100 units)  
**NEW**



**SC-1623**  
Steel spacers for 3/16 guides



**SC-5116**  
M5 stainless steel nuts x 2.5mm for 3/16"  
guides



Aluminium hubs for 3mm axle

Supplied in bags of 2 units with M3 screws

for Sponge tyres



Lightweight Design			
Width	Ø D1	Ø D2	Reference
8'0 mm	21'0 mm	21'0 mm	SC-4003
13'0 mm	21'0 mm	21'0 mm	SC-4004



Coarse Design			
Width	Ø D1	Ø D2	Reference
10'0 mm	21'0 mm	21'0 mm	SC-4000
16'0 mm	21'0 mm	21'0 mm	SC-4001

for rubber tyres



Solid Design			
Width	Ø D1	Ø D2	Reference
10'0 mm	23'5 mm	21'5 mm	SC-4042
13'0 mm	23'5 mm	21'5 mm	SC-4043



Jarama			
Width	Ø D1	Ø D2	Reference
10'0 mm	21'0 mm	19'0 mm	SC-4057e
13'0 mm	21'0 mm	19'0 mm	SC-4056e



Lightweight Design			
Width	Ø D1	Ø D2	Reference
9'0 mm	22'2 mm	20'0 mm	SC-4037b
10'0 mm	21'0 mm	19'0 mm	SC-4057f
10'0 mm	22'0 mm	20'0 mm	SC-4055f
10'2 mm	19'5 mm	17'3 mm	SC-4019
10'2 mm	20'5 mm	18'0 mm	SC-4029
11'5 mm	22'2 mm	20'0 mm	SC-4036b
13'0 mm	21'0 mm	19'0 mm	SC-4056f
13'0 mm	22'0 mm	20'0 mm	SC-4050f

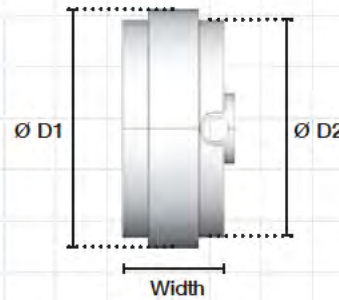

Rubber tyres for 1/24

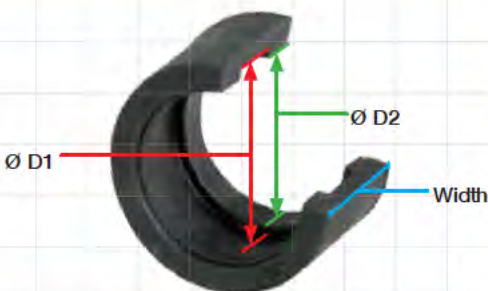

Width	Ø D1	Minimum Ø D2	Slick			Stripped	
			Standard	RT	Medium	Soft	RT
10'0 mm	26'0 mm	20'0 mm	SC-4716				
12'0 mm	24'0 mm	16'0 mm		SC-4732		SC-4731	SC-4730 SC-4729
13'0 mm	25'0 mm	20'0 mm					SC-4725
13'0 mm	25'0 mm	19'0 mm			SC-4737	SC-4736	
13'0 mm	27'0 mm	20'0 mm	SC-4717				

Sponge tyres for 1/24



Width	Diameters in mm		Procomp	Procomp 2	Procomp 3	Hardcomp
	D	D2				
9'0	26'5	21'0		SC-4854		
12'0	28'0	20'0				SC-4840
14'0	26'5	21'0		SC-4853		
20'0	30'0	16'0	SC-4804	SC-4852	SC-4832	
20'0	30'0	20'0	SC-4802	SC-4850	SC-4830	



**Wheel inserts (set of 4 units)**



**SC-7609**  
Speedline 15 spokes  
Wheel insert Ø 16/17 mm.



**SC-7606**  
Speedline 5 spokes  
Wheel insert Ø 20 mm.



**SC-7610**  
BBS GT Wheel insert  
Ø 20 mm. with brake disk



**SC-7618**  
15 Spokes modern GT LMS Hubs  
Ø 20 mm with brake disks



**SC-7607**  
OZ Wheel insert Ø 16/17 mm



**SC-7608**  
Speedline 15 spokes.  
Wheel insert Ø 20 mm.



**SC-7615**  
BBS GT 15 Spokes Wheel insert  
Ø 20 mm. with brake disc.



**SC-7619** **NEW**  
5 spokes Classic wheel insert  
Ø 17-19 mm

**Self sticking ballast**

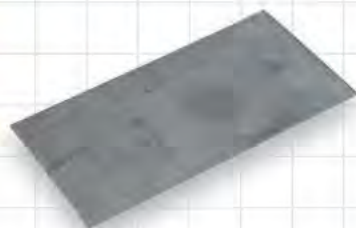

Provided with convenient easy-peel high strength adhesive layer

Reference	Description
SC-1510	Special self sticking ballast 100 x 50 x 1.5 mm
SC-1511	Special self sticking ballast 100 x 50 x 1 mm
SC-1512	Special self sticking ballast 100 x 50 x 0.5 mm
SC-1513	Special self sticking ballast 100 x 50 x 2 mm

**Nuts and Screws**

High quality steel ball bearing 3mm Axle



**SC-5124** **NEW**  
Allen head screw M2x4  
(10 units)



**SC-5125** **NEW**  
Allen rounded head  
screw M2x3'4'6'8'10  
(10 units each)



**SC-5126** **NEW**  
Allen rounded head  
screw M2x4  
(10 units)

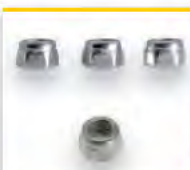

**SC-5100**  
Selflocking nuts  
M2 x 4.5 mm (10 units)

**SC-5118**  
Selflocking nuts  
M2 x 4 mm (10 units)



**SC-5101**  
M2 inox hardened nuts (10 units)

**SC-5102**  
M2 nylon nuts (10 units)



**SC-5119**  
Assorted screw set  
(10 units)



**SC-5106**  
Flat nylon screw  
M2 x 10mm (10 units)



**SC-5105**  
Phillips steel screw conic head  
M2 x 8mm (10 units)

**SC-5123**  
Phillips set screw sorted  
M2x4'6'8'10'12



**SC-5104**  
Phillips steel screw  
(10 units)



**SC-5109**  
Allen screw M2x4mm (10 units)

**SC-5110**  
Steel allen screw M2 x 6mm (10 u.)



**SC-5117**  
Titanium allen screw  
M2 x 6mm (10 units)



**SC-5111**  
Allen inox screw M2 x 6mm  
Hubs/Gears (10 units)

**SC-5112**  
Allen inox screw M3 x 3mm  
Hubs/Gears (10 units)



**SC-5103**  
Inox M2 self blocking  
spacers (10 units)



**SC-5106**  
Flat nylon screw  
M2 x 10mm (10 units)



**SC-5120**  
Countersunk M2 Titanium  
screws (20 units)  
4 x M2x4 • M2 x 6 • M2 x 8  
M2 x 10 • M2 x 12



**SC-5121**  
Flat M2 Titanium screws  
(20 units)  
4 x M2x2 • M2x4 • M2x6  
M2x8 • M2x10



**SC-5122**  
Half thread M2 Titanium  
screws (6 units)  
2 x M2x8 • M2 x 10 • M2 x 12

**SC-5127** **NEW**  
Half thread M2 Brass  
screws (6 units)  
2 x M2x8 • M2 x 10 • M2 x 12



# SRT VIPER RGT-R-R

SC-6036 • NEW •

ALMS Mid Ohio 2012 #93

SRT Motorsport Team VIPER



SC-6037 • NEW •

ALMS Mid Ohio 2012 #91

SRT Motorsport Team VIPER



	S-CAN	LONG-CAN	SHORT-CAN	SLIM-CAN	FLAT-CAN
Slim In-line	YES	YES	YES	YES	YES
Side Winder	YES	NO	YES	NO	NO
Angle Winder	YES	YES	YES	NO	YES

	Reference	Motor	Motor Size	Ratio	Magnet	Chassis	Lights	Front (mm)		Rear (mm)	
								ø Tire	Hub	ø Tire	Hub
ALMS Mid Ohio 2012 #93	SC-6036	SC-08b	SideWinder Short Can	12/32	YES	RT3 MWB	NO	18 x 9	17'5 x 9	19 x 10'5	17'5 x 10
ALMS Mid Ohio 2012 #91	SC-6037							Standard	Plastic	Standard	Aluminium



# HSV-010 Super GT

## GT Racing Models

SC-6015  
JGTC 2010 #8  
Autobacs



SC-6033 • **NEW** •  
JGTC 2010 #17  
Keihin

SC-6031  
JGTC 2010 #100  
Raybrig



SC-6012  
JGTC 2010 Presentation  
Raybrig

1.000 units limited edition

	S-CAN	LONG-CAN	SHORT-CAN	SLIM-CAN	FLAT-CAN
Slim In-line	YES	YES	YES	YES	YES
Side Winder	YES	NO	YES	NO	NO
Angle Winder	YES	YES	YES	NO	YES

	Reference	Motor	Motor Size	Ratio	Magnet	Chassis	Lights	Front (mm)		Rear (mm)	
								ø Tire	Hub	ø Tire	Hub
Presentation	SC-6012	SC-08b	Sidewinder Short Can	12/32	YES	RTS LWB	NO	18 x 9 Standard	17'5 x 9 Plastic	19 x 10'5 Standard	17'5 x 10 Aluminium
JGTC 2010 #8	SC-6015										
JGTC 2010 #32	SC-6030										
JGTC 2010 #100	SC-6031										
JGTC 2010 #17	SC-6033										



# BMW Z4 GT3

**SC-6018**  
**24h Dubai 2011 #17**  
*Team Engstler*



**• NEW • SC-6028**  
**Super GT 2011 #4**  
*Studie AGs*



**SC-6020**  
**24h Barcelona 2011 #2**  
*Schubert Motorsport*

	S-CAN	LONG-CAN	SHORT-CAN	SLIM-CAN	FLAT-CAN
Slim In-line	YES	YES	YES	YES	YES
Side Winder	YES	NO	YES	NO	NO
Angle Winder	YES	YES	YES	NO	YES

	Reference	Motor	Motor Size	Ratio	Magnet	Chassis	Lights	Front (mm)		Rear (mm)	
								ø Tire	Hub	ø Tire	Hub
Presentation #1	SC-6017	SC-08b	Sidewinder	12/32	YES	RT3 MWB	NO	18 x 9 Standard	17'5 x 9 Plastic	19 x 10'5 Standard	17'5 x 10 Aluminium
24h Dubai 2011 #17	SC-6018										
24h Barcelona 2011 #2	SC-6020										
Super GT 2011 #4	SC-6028										



# SPYKER C8 GT2R

**• NEW • SC-6042**  
**C8 24h LM 2006 #86**

Spyker Squadron BV



**SC-6026 • NEW •**

**C8 24 LM 2007 #85 & #86**

Spyker Squadron BV



	S-CAN	LONG-CAN	SHORT-CAN	SLIM-CAN	FLAT-CAN
Slim In-line	YES	YES	YES	YES	YES
Side Winder	YES	NO	YES	NO	NO
Angle Winder	YES	YES	YES	NO	YES

	Reference	Motor	Motor Size	Ratio	Magnet	Chassis	Lights	Front (mm)		Rear (mm)	
								ø Tire	Hub	ø Tire	Hub
C8 24 LM 2007 #85 & #86	SC-6026	SC-08b	SideWinder	12/32	YES	RT3 MWB	NO	18 x 9	17'5 x 9	19 x 10'5	17'5 x 10
C8 24h LM 2006 #86	SC-6042		Short Can					Standard	Plastic	Standard	Aluminium



# Pagani Zonda

SC-6044

Brno 2010 #39

Rock Media Motors



**NEW** SC-6045

24h LM Test 2004 #60

Force One Racing



SC-6046b **NEW**  
White Body Racing Kit

	S-CAN	LONG-CAN	SHORT-CAN	SLIM-CAN	FLAT-CAN
Slim In-line	YES	YES	YES	YES	YES
Side Winder	YES	NO	YES	NO	NO
Angle Winder	YES	YES	YES	NO	YES

	Reference	Motor	Motor Size	Ratio	Magnet	Chassis	Lights	Front (mm)		Rear (mm)	
								ø Tire	Hub	ø Tire	Hub
Brno 2010 #39	SC-6044		In-Line	27/9				18 x 9	17'5 x 9	19 x 10'5	17'5 x 10
24h LM Test 2004 #60	SC-6045	SC-26	Long Can		YES	RT2	NO	Standard	Plastic	Standard	Aluminium
White Body Racing Kit	SC-6046b		AW	28/12							



# Mercedes Benz SLS AMG GT3

**SC-6023**  
**24h Nürburgring 2011 #3**  
*Black Falcon*



**SC-6021 • NEW •**  
**VLN Nürburgring 2011 #15**  
*Mamerow Racing*



**SC-6022 • NEW •**  
**IberGT 2011 Jarama #25**  
*Vodafone BP Ultimate Team*

	S-CAN	LONG-CAN	SHORT-CAN	SLIM-CAN	FLAT-CAN
Slim In-line	YES	YES	YES	YES	YES
Side Winder	YES	NO	YES	NO	NO
Angle Winder	YES	YES	YES	NO	YES

	Reference	Motor	Motor Size	Ratio	Magnet	Chassis	Lights	Front (mm)		Rear (mm)	
								ø Tire	Hub	ø Tire	Hub
Laureus Special Edition	SC-6019	SC-26	In-Line Long Can	27/9	YES	RT2	NO	18 x 9 Standard	17'5 x 9 Plastic	19 x 10'5 Standard	17'5 x 10 Aluminium
VLN Nürburgring 2011 #15	SC-6021										
IberGT Jarama 2011 #25	SC-6022										
VLN Nürburgring 2011 #3	SC-6023										





# Radical SR-9

**SC-6011**  
**24h LM 2010 #28**  
*Race Performance AG*





**SC-6010**  
**24h LM 2009 #26**  
*Bruichladdich Bruneau*



	S-CAN	LONG-CAN	SHORT-CAN	SLIM-CAN	FLAT-CAN
Slim In-line 	YES	YES	YES	YES	YES
Side Winder 	NO	NO	NO	NO	NO
Angle Winder 	NO	NO	NO	NO	YES

• New chassis RT2 & EVO-6 compatible •

	Reference	Motor	Motor Size	Ratio	Magnet	Chassis	Lights	Front (mm)		Rear (mm)	
								ø Tire	Hub	ø Tire	Hub
24h LM 2006 #22	SC-6006	SC-25	In-Line 	27/9	YES	RT	NO	19 x 10'5	17'2 x 9	19 x 10'5	17'2 x 10
24h LM 2007 #21	SC-6009										
24h LM 2009 #26	SC-6010					Long Can 	RT-2	Standard	Plastic	Standard	Aluminium
24h LM 2010 #28	SC-6011										



# Porsche 935

• NEW • SC-6029

**DRM Zolder 1977 #52**

*Team Max Moritz*





• NEW • SC-6047

**24h Daytona 1979 winner**

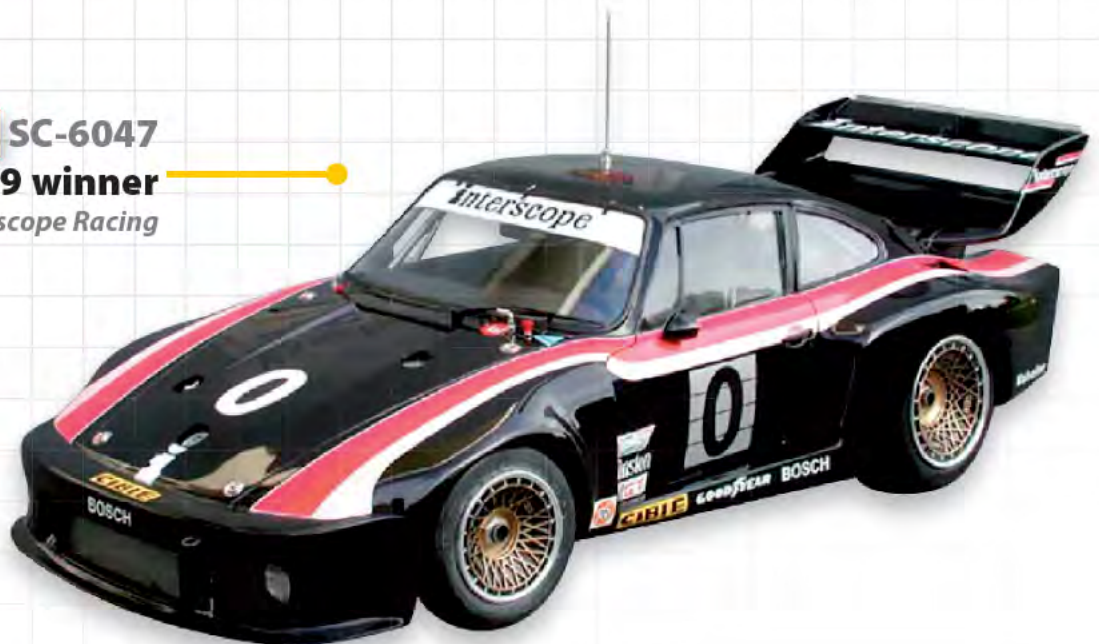
*Interscope Racing*



	S-CAN	LONG-CAN	SHORT-CAN	FLAT-CAN	SLIM-CAN
Side Winder 	YES	NO	YES	NO	NO
Angle Winder 	NO	NO	NO	NO	NO

	Reference	Motor	Motor Size	Ratio	Magnet	Chassis	Lights	Front (mm)		Rear (mm)	
								ø Tire	Hub	ø Tire	Hub
DRM Zolder 1977 #52	SC-6029	SC-08b	Sidewinder	12/32	YES	R13 SWB	NO	18 x 9 Standard	15'8 x 9 Plastic	22 x 11 Standard	17'5 x 10 Aluminium
24h Daytona 1979 winner	SC-6047	SC-08b	Short Can								



# M1 Gr. 5

SC-6039

500 Km Fuji 1982 #8

Team Seelex



SC-6024

24h LM 1981 #53

Emka Productions Ltd



SC-6027

24h LM 1981 #52

Wurth Team Sauber

	S-CAN	LONG-CAN	SHORT-CAN	SLIM-CAN	FLAT-CAN
In-line	YES	YES	YES	YES	YES
Side Winder	YES	NO	YES	NO	NO
Angle Winder	YES	YES	YES	NO	YES

	Reference	Motor	Motor Size	Ratio	Magnet	Chassis	Lights	Front (mm)		Rear (mm)	
								ø Tire	Hub	ø Tire	Hub
24h LM 1981 #53	SC-6024	SC-08b	Sidewinder	12/32	YES	RT3 MWB	NO	18 x 9 Standard	15'9 x 9 Plastic	22 x 11 Standard	16'9 x 9 Aluminium
24h LM 1981 #52	SC-6027										
500 Km Fuji 1982 #8	SC-6039		Short Can								



# De Tomaso Pantera Gr. 3

SC-6034

Supplied with decals

24h LM 1976 #82

André Wicky - Martial Deblande

24h LM 1974 #52

Wicky Racing Team



SC-6035

24h LM 1975 #7

Beurlys Inter Auto

SC-6040

DRM #318 Jagermeister

Bonhorst



	S-CAN	LONG-CAN	SHORT-CAN	SLIM-CAN	FLAT-CAN
In-line	YES	YES	YES	YES	YES
Side Winder	YES	NO	YES	NO	NO
Angle Winder	YES	YES	YES	NO	YES

	Reference	Motor	Motor Size	Ratio	Magnet	Chassis	Lights	Front (mm)		Rear (mm)	
								ø Tire	Hub	ø Tire	Hub
24h LM 1974 #52 / 1976 #82	SC-6034	SC-08b	Sidewinder	12/32	YES	RT3 MWB	NO	18 x 9 Standard	16'9 x 9 Plastic	19 x 10'5 Standard	16'9 x 9 Aluminium
24h LM 1975 #7	SC-6035		Short Can								
DRM #318	SC-6040										



# RT3 Chassis Design

Valid for In-line, Sidewinder and Anglewinder motor mounts

2 front fixing arms style for motor mounts

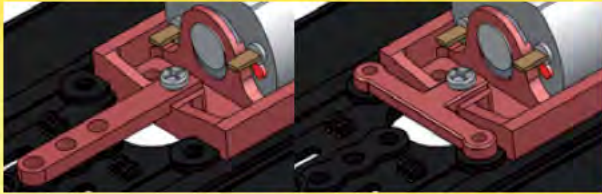

Geometry and properties can be easily modified exchanging this piece. Up to 4 motor mount front fixing points. Extended range of compatibility for motor mounts from third party brands.

Easily rear magnet assembly



With only 2 screws allows an easy to fix, adjustable rear magnet installation to assure the maximum speed.

Adjustable suspension post



Sided screws to adjust the motor mount vertical play. They also allow the mounting of suspension kit.

Wire fixings

Wiring supports for clear installation on chassis surface

Body floating concept

4 motor mount rear fixing post with adjustable vertical play or suspension assembly.

One chassis for different bodies



Adjustable car wheelbase, modifying the position of front axle housing. Adjustable front axle height to minimize the friction. Now using 1 chassis for different bodies is possible!!

Independent guide holder



Adjustable guide position to rear and front axle.

2 lenght available

Surface distance also adjustable using fine spacers



Reference	Description
SC-6623	Chassis RT3 MWB assembled + LWB main base as optional assembly

**• NEW •**

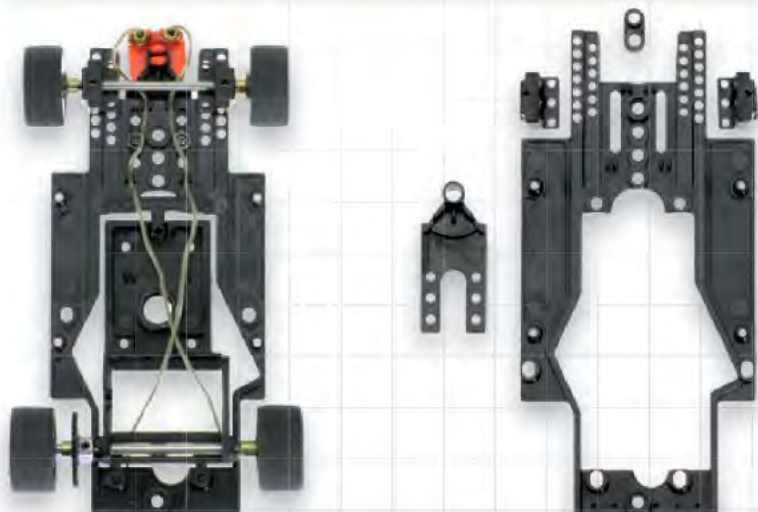

Reference	Description	Width	Wheelbase
SC-6616	Long Wheel Base Chassis (hard)	57'0	81-86 mm
SC-6616b	Long Wheel Base Chassis (soft)		

Reference	Description	Width	Wheelbase
SC-6615	Medium Wheel Base Chassis (hard)	50'6 mm	77-84 mm
SC-6615b	Medium Wheel Base Chassis (soft)		

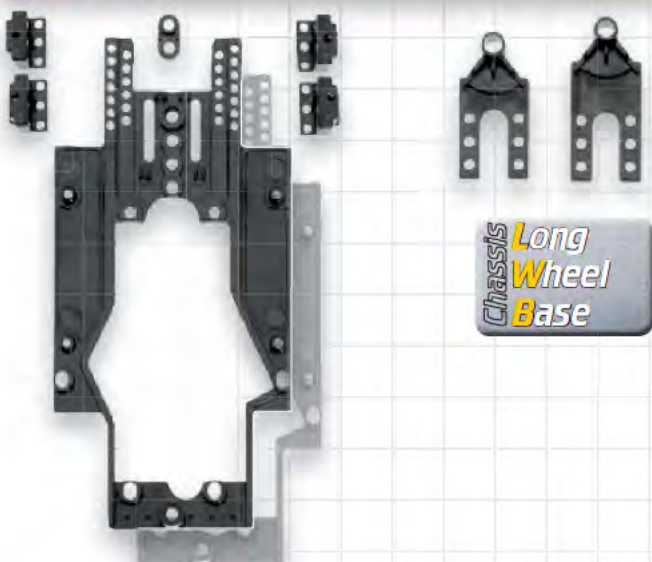

**Chassis Long Wheel Base**

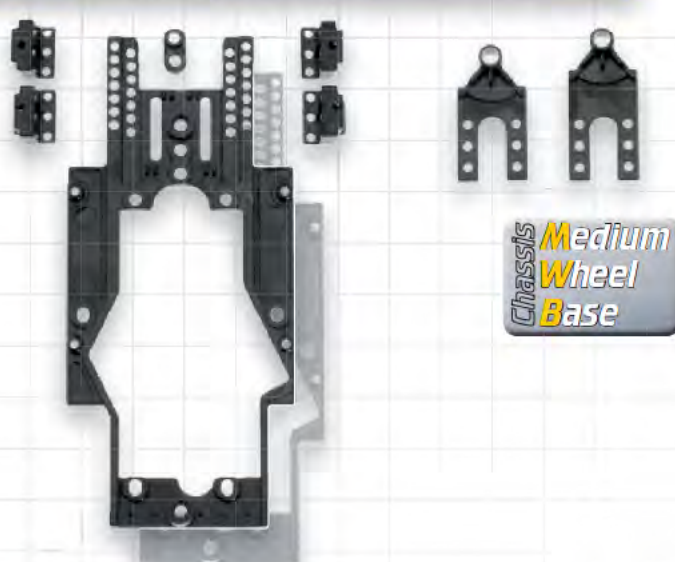

**Chassis Medium Wheel Base**

Reference	Description	Width	Wheelbase
SC-6622	Small wheel base (hard)	44 mm	67-79 mm
SC-6622b	Small wheel base (soft)		

Reference	Description	Width	Wheelbase
SC-6628	X-Small wheel base chassis (hard)	40 mm	67-73 mm

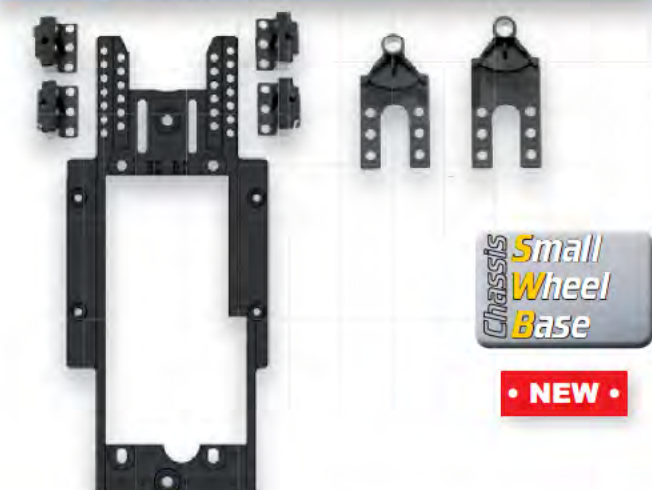

**Chassis Small Wheel Base**

**• NEW •**

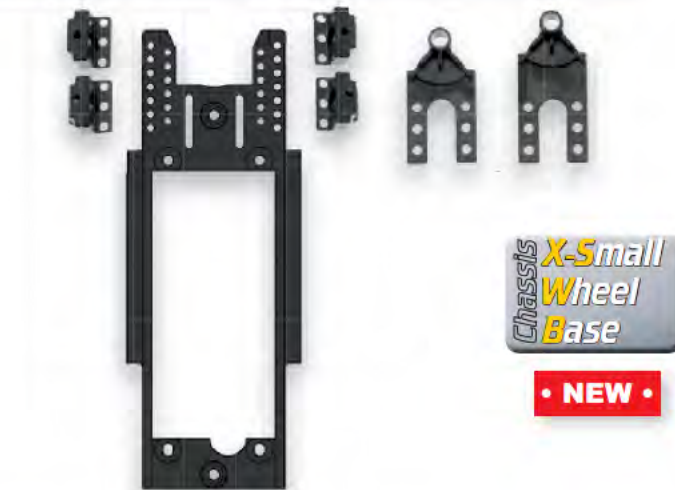

**Chassis X-Small Wheel Base**

**• NEW •**



Reference	Description
SC-6522	RT3 Motor mount offset 0'5mm Sidewinder

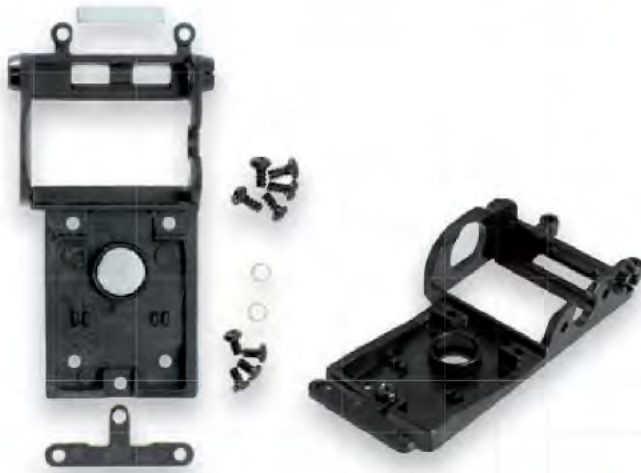

Reference	Description
SC-6523	RT3 Motor mount In-Line



Reference	Description
SC-6524	RT3 motor mount AW offset 0'5 mm



Reference	Description
SC-6524	RT3 motor mount offset 0'0 mm Sidewinder

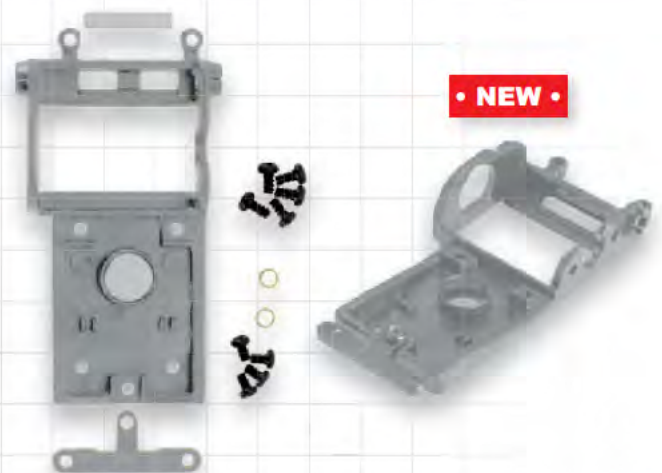

Reference	Description
SC-6527	RT3 motor mount In-Line Slim

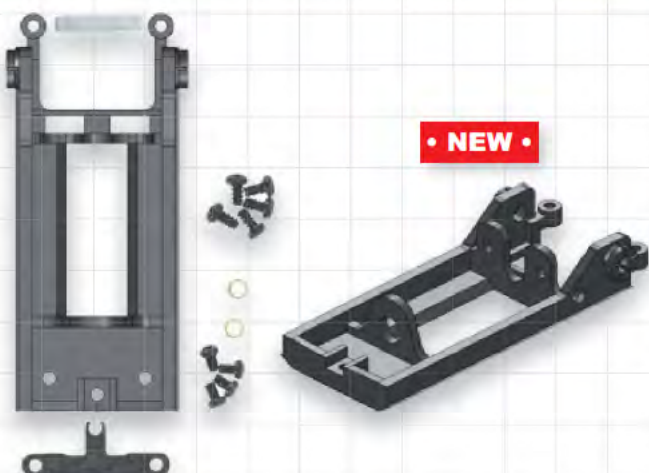

Reference	Description
SC-6525a	RT3 motor mount ARMS (carbon fiber) for AW-IL-SW

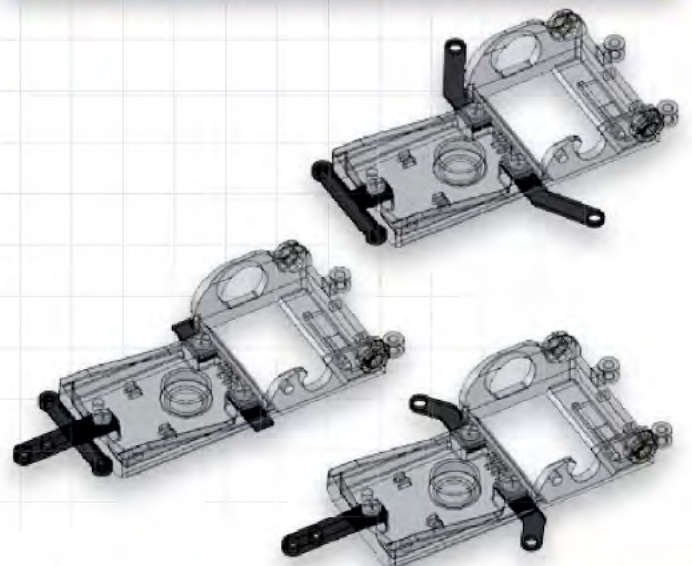



**Chassis RT2**

**Chassis Toyota GT One**

SC-6605 Hard



**Chassis Radical SR-9**

SC-6612 Hard  
 SC-6612b Medium  
 SC-6612c Soft

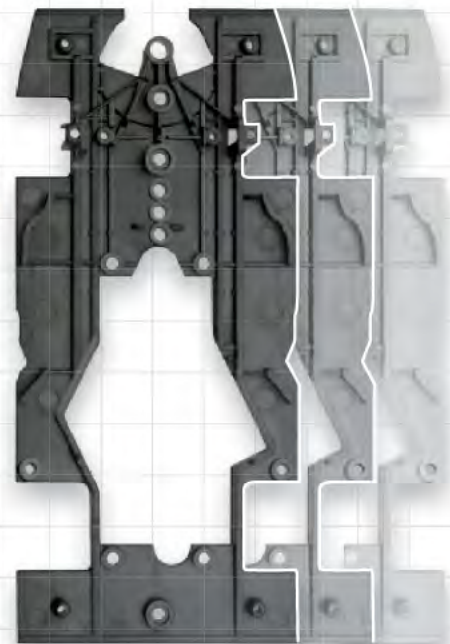

**Chassis Radical SR-9 Evo2**

SC-6612a2 Hard  
 SC-6612b2 Medium  
 SC-6612c2 Soft

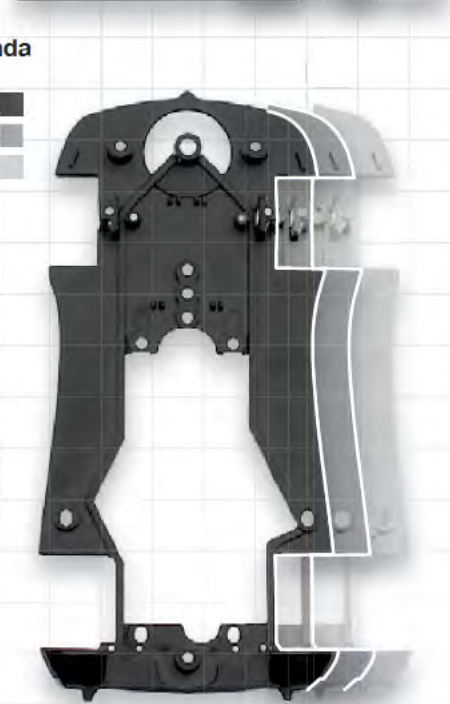

**Chassis Mercedes Benz SLS AMG GT3**

SC-6613a Hard  
 SC-6613b Medium  
 SC-6613c Soft

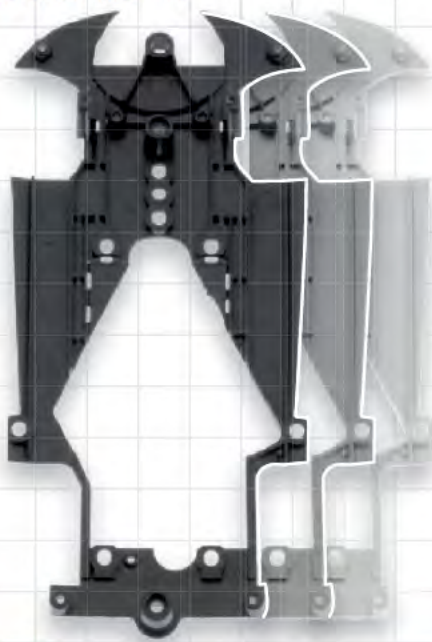

**Chassis Pagani Zonda**

SC-6621a Hard  
 SC-6621b Medium  
 SC-6621c Soft

**• NEW •**

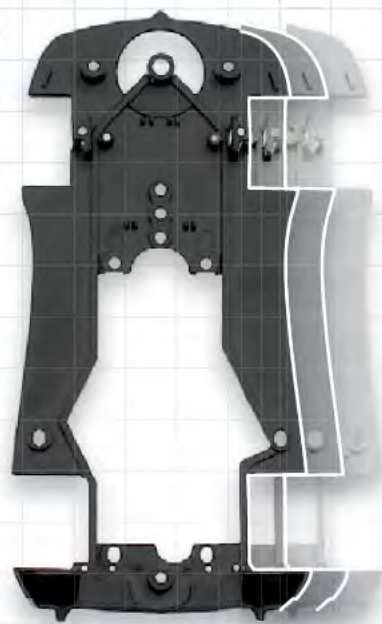

**RT2 Motor Mounts**



SC-6520  
 RT2 In-Line motor mount offset 0,5 mm



SC-6521  
 RT2 AngleWinder Soft motor offset 0,5 mm (white)



SC-6521b  
 RT2 AngleWinder Hard motor offset 0,5 mm (black)



Aluminium / Carbon Motor Mounts



In-Line

SC-3000b

PRO RT In-Line Aluminium.

Motor mount for:

Scaleauto • MSC • Slot.It • Racer sideways  
Arrow Slot

- ✓ Perfect CNC Aluminium machined.
- ✓ Ultra light design for minimum weight and maximum speed.
- ✓ Interchangeable motor mount with or without offset set inline gears.
- ✓ Optional High Speed Ball Bearing (SC-1321).



SC-3050

Offset Motor mount -0'5mm.  
(Only for discontinued reference SC-3000)



SC-3051

Magnet mount for 2 x SC-1502 neodymium magnets.  
Adjustable height with double screw fixing.  
(Only for discontinued reference SC-3000)



AngleWinder

SC-3001c

PRO-RT Anglewinder Aluminium motor mount.

- ✓ Perfect CNC aluminium motor mounts
- ✓ Ultra light design for minimum weight and maximum speed
- ✓ Anglewinder motor mount compatible with plastic chassis from:  
Scaleauto • Racer Sideways • MSC • Slot.It • Arrow Slot
- ✓ Allow LONG can or FLAT can motors
- ✓ Optional High Speed Ball Bearing (SC-1321)
- ✓ Compatible with chassis type RT-2 and EVO-6



SideWinder

SC-3004b

PRO-RT Sidewinder  
Aluminium motor mount for NSR classic.

- ✓ Perfect CNC aluminium motor mounts
- ✓ Ultra light design for minimum weight and maximum speed
- ✓ Sidewinder motor mount compatible with plastic chassis from NSR
- ✓ For S-CAN motors
- ✓ Optional High Speed Ball Bearing (SC-1321).

• UPDATED DESIGN •





### Suzuka Aluminium Anodized • NEW •



● Black Anodized

Diameters in mm		Width	Reference
D	D2		
14'8	12'7	8'5 mm	SC-4030g
15'5	13'3		SC-4053g
15'8	13'6		SC-4031g
16'2	14'0		SC-4049g
17'2	15'0		SC-4034g
17'5	15'3		SC-4052g

### Sebring Aluminium Anodized • NEW •



● Dark Grey Anodized

Diameters in mm		Width	Reference
D	D2		
14'8	12'7	8'5 mm	SC-4030h
15'5	13'3		SC-4053h
15'8	13'6		SC-4031h
16'2	14'0		SC-4049h
17'2	15'0		SC-4034h
17'5	15'3		SC-4052h

### Lightweight Universal



Diameters in mm		Width	Reference
D	D2		
14'8	12'7	8'5 mm	SC-4030f
15'8	13'6	8'5 mm	SC-4031f
15'8	13'6	10'0 mm	SC-4032f
17'2	15'0	10'0 mm	SC-4033f
17'2	15'0	8'5 mm	SC-4034f
14'8	12'7	10'0 mm	SC-4035f
16'5	14'3	8'5 mm	SC-4046f
16'9	14'7	8'5 mm	SC-4048f
16'2	14'0	8'5 mm	SC-4049f
16'2	14'0	10'0 mm	SC-4051f
17'5	15'3	8'5 mm	SC-4052f
15'5	13'3	8'5 mm	SC-4053f
16'5	14'3	10'0 mm	SC-4054f
17'5	15'3	10'0 mm	SC-4062f

### Jarama Aluminium Gold Anodized



Diameters in mm		Width	Reference
D	D2		
15'5	13'3	8'5 mm	SC-4053e
15'8	13'6		SC-4031e
16'2	14'0		SC-4049e
16'5	14'3		SC-4046e
16'9	14'7		SC-4048e
17'2	15'0		SC-4034e
17'5	15'3	SC-4052e	

### Monza Magnesium



Diameters in mm		Width	Reference
D	D2		
14'8	12'7	8'0 mm	SC-4030b
16'5	14'3	8'0 mm	SC-4046b
14'8	12'7	10'0 mm	SC-4035b

### Solid Design



Diameters in mm		Width	Reference
D	D2		
15'0	12'8	8'0 mm	SC-4063a
15'8	13'6	8'5mm	SC-4031a
15'8	13'6	10mm	SC-4032a
16'9	14'1	8'5mm	SC-4048a
17'5	15'5	8'5mm	SC-4052a

### Monza-2 Aluminium



Diameters in mm		Width	● Silver ○ Black ● Blue ● Dark grey			
D	D2					
16'9	14'7	8'0 mm	SC-4048d2	SC-4048d3	SC-4048d4	
14'8	12'7		SC-4030d			
15'5	13'3	8'5 mm	SC-4053d			
15'8	13'6		SC-4031d			
16'2	14'0		SC-4049d			
17'2	15'0		SC-4034d			
17'5	15'3		SC-4052d			

### Imola Aluminium



Diameters in mm		Width	● Silver ○ Black ● Blue ● Dark grey		
D	D2				
16'5	14'3	8'0 mm	SC4046c2	SC4046c3	
16'9	14'7		SC-4048c2	SC-4048c3	SC-4048c4





R+D Team »»» Leading Standards

### New standard for gear tooth identification

Scaleauto's gear range is ruled under the new Color Code that states a unique color to each gear depending on the amount of teeth.

Standardization makes tuning experience smoother for the serious Professional Slot Racer.

### NEW INTERNATIONAL COLOR CODE

Color	Gear theeth	Color	Gear theeth
	20 / 30 / 40		25 / 36 / 45
	21 / 31 / 41		26 / 36 / 46
	22 / 32 / 42		27 / 37 / 47
	23 / 33 / 43		28 / 38 / 48
	24 / 34 / 44		29 / 39 / 49



#### In-line Procomp R5



Black aluminium insert				
Teeth		Ø	Screw	Reference
23		12'8	M2	SC-1109
24		13'1	M2	SC-1110
25		13'5	M2	SC-1111
26		14'1	M2	SC-1112
27		14'8	M2	SC-1113
28		15'4	M2	SC-1114
30		16'2	M2	SC-1115



SC-1123  
STOPPER Aluminium  
Screw: M2 + STOPPER



#### Anglewinder Procomp R5

NEW



For 25° motor mounts			
Black aluminium insert		Green aluminium insert	
Screw: M2 • ø 15'8 mm		Screw: M2 • ø 17'0 mm	
Teeth	Reference	Teeth	Reference
25	SC-1185	31	SC-1171
26	SC-1186	31*	SC-1171b
27	SC-1187	32	SC-1172
28	SC-1188	32*	SC-1172b
29	SC-1189		
30	SC-1170		

\* Reverse fitted



Standard

\* Reverse fitted

For 15° motor mounts.					
Gold aluminium insert		Gold aluminium insert		Gold aluminium insert	
Screw: M2 • ø 16'5 mm		Screw: M2 • ø 16'75 mm		Screw: M2 • ø 17'0 mm	
Teeth	Reference	Teeth	Reference	Teeth	Reference
25	SC-1175	29	SC-1179	33	SC-1183
26	SC-1176	30	SC-1180	34	SC-1184
27	SC-1177	31	SC-1181	35	SC-1185
28	SC-1178	32	SC-1182	36	SC-1186



#### SideWinder Procomp R5

NEW



Blue aluminium insert		Red aluminium insert	
Screw: M2 • ø 17'5 mm		Screw: M2 • ø 18'5 mm	
Teeth	Reference	Teeth	Reference
31	SC-1151	33	SC-1143
32	SC-1152	34	SC-1144
33	SC-1153	35	SC-1145
34	SC-1154	36	SC-1146
35	SC-1155	37	SC-1147
36	SC-1156		

#### Axle accessories



SC-1124  
3/32" Axle stopper light and anodized. M2 Screw



## Body Kits and Body Spares



Reference	Body kits
SC-3600	Toyota GT One (white)
SC-3600b	Toyota GR One painted body (red)
SC-3601	Radical SR-9 (white)
SC-3602	Mercedes Benz SLS GT3 (white)
SC-3603	HSV-010
SC-3604	BMW Z4 GT3
SC-3605	Spyker C8 GT2-R
SC-3606	Pagani Zonda
SC-3608	M1 Gr. 5 <b>NEW</b>
SC-3609	DeTomaso Pantera <b>NEW</b>
SC-3610	SRT VIPER GTS-R <b>NEW</b>
SC-3611	Porsche 935 <b>NEW</b>

Reference	Body spare parts
SC-3601b	Radical SR-9
SC-3602b	Mercedes Benz SLS AMG GT3
SC-3603b	HSV-010
SC-3604b	BMW Z4 GT3
SC-3605b	Spyker C8 GT2-R
SC-3606b	Pagani Zonda
SC-3608b	M1 Gr. 5 <b>NEW</b>
SC-3609b	DeTomaso Pantera <b>NEW</b>
SC-3610b	SRT VIPER GTS-R <b>NEW</b>
SC-3611b	Porsche 935 <b>NEW</b>

## Ultra light cockpit



Reference	Complete light cockpit and clear pieces
SC-6602	Toyota GT-One
SC-6611	Radical SR-9
SC-6614	Mercedes Benz SLS AMG GT3
SC-6617	HSV-010
SC-6618	BMW Z4 GT3
SC-6619	Spyker C8 GT2-R
SC-6620	Pagani Zonda
SC-6624	M1 Gr. 5 <b>NEW</b>
SC-6625	DeTomaso Pantera <b>NEW</b>
SC-6626	SRT VIPER GTS-R <b>NEW</b>
SC-6627	Porsche 935 <b>NEW</b>

## Performance Kit



Reference	Rear wing (Rubber + Carbon fiber)
SC-3601e	Radical SR-9
SC-3602e	Mercedes Benz SLS AMG GT3
SC-3603e	HSV-010
SC-3604e	BMW Z4 GT3
SC-3605e	Spyker C8 GT2-R <b>NEW</b>
SC-3606e	Pagani Zonda <b>NEW</b>
SC-3610e	SRT VIPER GTS-R <b>NEW</b>

Reference	Rubber mirror + Antenna
SC-3607	Rubber mirrors + antenna <b>NEW</b>



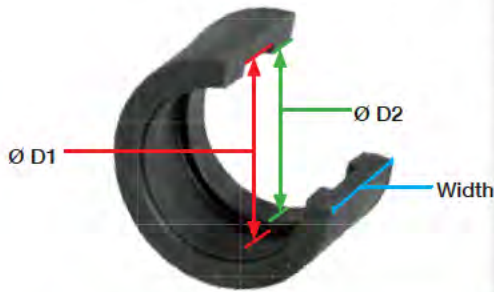

Rubber tyres for 1/32



Rubber tyres for profile hubs. Supplied in bags of 4 units.

Ø D1	Width	Ø D2	Type Hardness					
			Standard	Zero Grip	RT	Medium	Soft	
15'8 mm	8'0 mm	13'0 mm		SC-4743 <b>NEW</b>	SC-4742			
16'0 mm	8'5 mm	14'0 mm		SC-4724	SC-4738			
17'5 mm	10'0 mm	16'0 mm		SC-4723				
18'0 mm	9'0 mm	14'5 mm	SC-4746 <b>NEW</b>		SC-4734	SC-4739		
18'5 mm	10'0 mm	15'0 mm	SC-4718					
19'0 mm	10'0 mm	14'0 mm			SC-4720		SC-4726	
19'0 mm	10'5 mm	15'0 mm			SC-4733			
19'5 mm	8'8 mm	15'0 mm	SC-4719					
19'5 mm	10'0 mm	15'0 mm	SC-4747 <b>NEW</b>		SC-4735	SC-4740		
20'0 mm	9'5 mm	15'0 mm				SC-4741		
20'0 mm	10'0 mm	15'8 mm	SC-4744 <b>NEW</b>					
20'0 mm	10'0 mm	16'9 mm			SC-4722 <b>NEW</b>		SC-4728 <b>NEW</b>	
20'0 mm	12'0 mm	14'0 mm			SC-4721 <b>NEW</b>		SC-4727 <b>NEW</b>	
22'0 mm	11'0 mm	18'0 mm	SC-4745 <b>NEW</b>					



























Guides & accessories

 <p>SC-1603 Universal guide 7'9 mm blade with adjustable spacers</p> <p>SC-1604 Universal guide 6'8 mm blade with adjustable spacers</p>	 <p>SC-1605 Clip In Home Guide 7 mm</p>	 <p>SC-1606 Clip In Home Guide 7 mm with active suspension</p>
 <p>SC-1608 Italian cars guide 7mm blade with adjustable spacers</p> <p>SC-1607 Italian cars guide 8'3 mm blade with adjustable spacers</p>	 <p>SC-1620 Clip-in Home Rally Guide 7 mm</p>	 <p>SC-1621 Clip-in Home Rally Guide 7 mm with active suspension</p>
 <p>SC-1610 Red silicone wire 1 m length. Diameter: 1'3 mm Oxygen Free (0%)</p>	 <p>SC-1611 Black silicone wire 1 m length. Diameter: 1'3 mm Oxygen Free (0%)</p>	 <p>SC-1625 Clear Orange silicone wire 1 m length. Diameter: 0'9 mm Oxygen Free (0%)</p>
 <p>SC-1627 White silicone wire 1 m length. Diameter: 2 mm Oxygen Free (0%)</p>	 <p>SC-1633 Blue silicone wire 1m length. Diameter: 1'3 mm Oxygen Free (0%)</p>	
 <p>SC-1616 Guide terminals for 1/32 slot cars</p>	 <p>SC-1612 Universal soft braids</p> <p>SC-1613 Universal standard braids</p>	
 <p>SC-1630 <b>NEW</b> Superthin tinned braid 3'0 x 0'30. 1m length.</p>	 <p>SC-1631 <b>NEW</b> Superthin tinned braid 3'5 x 0'5. 1m length.</p>	



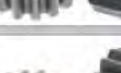

## Pinions M50 for 2mm motor shaft

2 units each pack

Aluminium	Steel	Brass
 <b>SC-1027</b> Diameter: 4'5 Teeth: 7	 <b>SC-1127</b> Diameter: 4'5 Teeth: 7	 <b>SC-1190</b> Diameter: 4'5 Teeth: 7
 <b>SC-1028</b> Diameter: 5'40 Teeth: 8	 <b>SC-1128</b> Diameter: 5'40 Teeth: 8	 <b>SC-1191</b> Diameter: 5'40 Teeth: 8
 <b>SC-1029</b> Diameter: 5'80 Teeth: 9	 <b>SC-1129</b> Diameter: 5'80 Teeth: 9	 <b>SC-1192</b> Diameter: 5'80 Teeth: 9
 <b>SC-1030</b> Diameter: 6'35 Teeth: 10	 <b>SC-1130</b> Diameter: 6'35 Teeth: 10	 <b>SC-1193</b> Diameter: 6'35 Teeth: 10
 <b>SC-1031</b> Diameter: 6'75 Teeth: 11	 <b>SC-1131</b> Diameter: 6'75 Teeth: 11	 <b>SC-1194</b> Diameter: 6'75 Teeth: 11
 <b>SC-1032</b> Diameter: 7'25 Teeth: 12	 <b>SC-1132</b> Diameter: 7'25 Teeth: 12	 <b>SC-1195</b> Diameter: 7'25 Teeth: 12
 <b>SC-1033</b> Diameter: 7'75 Teeth: 13	 <b>SC-1133</b> Diameter: 7'75 Teeth: 13	 <b>SC-1196</b> Diameter: 7'75 Teeth: 13
 <b>SC-1034</b> Diameter: 8'25 Teeth: 14	 <b>SC-1134</b> Diameter: 8'25 Teeth: 14	 <b>SC-1197</b> Diameter: 8'25 Teeth: 14
 <b>SC-1035</b> Diameter: 8'70 Teeth: 15	 <b>SC-1135</b> Diameter: 8'70 Teeth: 15	 <b>SC-1198</b> Diameter: 8'70 Teeth: 15

## Plastic nylon press-on pinions

	<b>SC-1005</b> Nylon M50 set Teeth (8' 9' 10'12' 14)		<b>SC-1006</b> <b>NEW</b> Nylon M50 12 teeth (4 units)
---	---	--	---

## Axles

Ø (D)	Length (L)	STEEL Qty	HOLLOW Qty	CARBON Qty	TITANIUM Qty
2'38 mm	50 mm	SC-1210 *	SC-1201		SC-1230
	55 mm	SC-1211 *	SC-1202	SC-1221	SC-1231
	60 mm	SC-1212 *			
	65 mm	SC-1213 *			
3 mm	60 mm	SC-1240 *		SC-1262	
	65 mm	SC-1241 *		SC-1263	
	70 mm	SC-1242 *			
	75 mm	SC-1243 *			
3 mm	65 mm	SC-1241b*	Specially for ceramic Ball Bearing superfine adjustment (SC-1335)		
	70 mm	SC-1242b*			

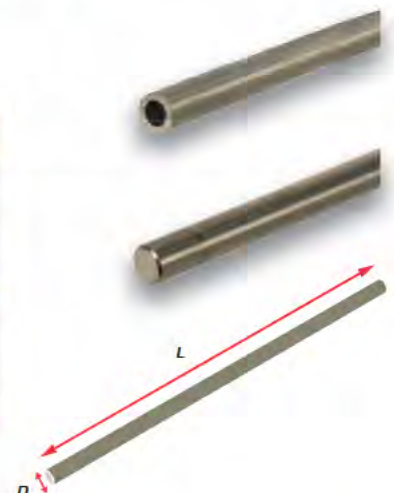

\* Supplied in pairs



	Tech 1 • 20.000 r.p.m.		Tech 2 • 25.000 r.p.m.		Tech 3 • 30.000 r.p.m.		
Type S-CAN Tested at 12V Size: 25x20x15mm Double shaft Plastic endbell 2 mm axle							
	SC-08b	4'5 gr <b>C</b>	SC-09	4'5 gr <b>C</b>	SC-10b	5'5 gr <b>C</b>	
	0'21 Amp	216 gr x cm	0'26 Amp	170 gr x cm	0'32 Amp	206 gr x cm	<b>Outlaw</b>

Type LONG-CAN Tested at 12V Size: 32'1x20'2x15'3mm Sealed endbell 2 mm axle							
	SC-11b	5 gr <b>C</b>	SC-12b	8 gr <b>C</b>	SC-13	9'5 gr <b>C</b>	33.000 r.p.m.
	0'18 Amp	205 gr x cm	0'25 Amp	280 gr x cm	0'32 Amp	330 gr x cm	0'54 Amp 360 gr x cm

Type SHORT-CAN Tested at 12V Size: 25x20x15mm Sealed endbell 2 mm axle							
	SC-14b	0'5 gr <b>C</b>	SC-15b	0'5 gr <b>C</b>	SC-16b	0'5 gr <b>C</b>	30.000 r.p.m.
	0'20 Amp	205 gr x cm	0'18 Amp	225 gr x cm	<b>• NEW •</b>	0'42 Amp	280 gr x cm

Type SLIM-CAN Tested at 12V Size: 26'9x15'5x12mm Sealed endbell 1'5 mm axle						
	SC-18	4'5 gr <b>C</b>	SC-19	4 gr <b>C</b>	SC-22	4'5 gr <b>C</b>
	0'16 Amp	90 gr x cm	0'22 Amp	100 gr x cm	0'28 Amp	120 gr x cm

	HOMESET		HOMESET		BB SERIES	
Type S-CAN Tested at 12V Size: 25x20x15mm Double shaft Plastic endbell 2 mm axle						
	Fits Fly, Ninco, MRRC, Scalextric, Proslot		Fits Fly, Ninco, MRRC, Scalextric, Proslot			
	SC-24	10.000 r.p.m.	SC-03	26.000 r.p.m.	SC-20	9 gr <b>C</b>
	0'08 Amp	100 gr x cm	0'22 Amp	100 gr x cm	0'20 Amp	170 gr x cm

	Sprinter Junior		Sprinter 2		Endurance	
Type LONG-CAN Tested at 12V Size: 32'1x20'2x15'3mm Sealed endbell 2 mm axle						
	<b>• NEW •</b>					
	SC-27	18.000 r.p.m.	SC-25b	22.000 r.p.m.	SC-26	22.000 r.p.m.
	0'28 Amp	300 gr x cm	0'28 Amp	300 gr x cm	0'20 Amp	320 gr x cm

All magnetic effect have been measured with MSC MPM units.



## Professional liquids

### Guides & Accessories



**SC-5303**  
White magic grease special for gears. 15 ml.



**SC-5302**  
Speed oil. Special for bearings and motors. 15 ml.



**SC-5304**  
Speed oil-2. Special for bearings and motors. 12 ml.

• NEW •



**SC-5300**  
Sponge/Rubber tyre cleaner.



**SC-5301**  
Slotgrip Sponge/Rubber tyre cleaner.

## Bushings and Bearings

2 units each pack

### Bronze and nylon bushing

	<b>SC-1354</b> Bronze 5 x mm Not flanged		<b>SC-1351</b> Bronze. 5mm x 3/32" Flanged.		<b>SC-1357</b> Bronze. 6mm x 3/32" Flanged.		<b>SC-1358</b> Bronze. 6mm x 3/32" Double flanged.
	<b>SC-1352b</b> Nylon 5mm x 3/32" Double flanged		<b>SC-1362b</b> Nylon 5mm x 3/32" Triple flanged		<b>SC-1325</b> Nylon 5mm x 3/32" Double flanged Bronze insert		

### High quality ceramic ball bearing

	<b>SC-1328</b> 5mm x 3/32" Open wall. Flanged. For 3/32" Axle		<b>SC-1335</b> 6 x 3mm Open wall. Flanged. For 3mm Axle
---	---	---	---

### High quality ball bearing

	<b>SC-1334</b> 6*35mm x 1/8" Flanged. For 1/8"mm Axle
--	--

### High quality steel ball bearing 3/32" Axle

	<b>SC-1319</b> 4*75mm x 3/32" Not flanged.		<b>SC-1320</b> 4*75mm x 3/32". Flanged.		<b>SC-1323</b> 5mm x 3/32" Double flanged. Width 2mm
	<b>SC-1321</b> 5mm x 3/32". Not flanged.		<b>SC-1322</b> 5mm x 3/32" Flanged. Width 2*5mm		<b>SC-1324</b> 5mm x 3/32" Double flanged. Width 1*7mm.
	<b>SC-1332</b> 6mm x 3/32" Not flanged. Width 2*6mm.		<b>SC-1329</b> 6mm x 3/32". Flanged.		

### High quality steel ball bearing 3mm Axle

	<b>SC-1330</b> 6 x 3mm Not flanged.		<b>SC-1331</b> 6 x 3mm Flanged.		<b>SC-1333</b> 6 x 3mm. Open wall. Flanged.
---	---	---	---------------------------------------	---	---



# High Performance Sponge Wheels

Developed by our R+D team, the 'state of the art' Sponge wheels deliver unprecedented performance for the most demanding slot racing competition enthusiasts.



**Hardcomp:**  
Zero grip Sponge, for front wheels only



**Procomp:**  
Soft high grip Sponge, specially for cold or low grip tracks. Short life



**Procomp 2:**  
Medium high grip Sponge, with special grip for plastic track



**Procomp 3:**  
Hard high grip Sponge, special for wooden tracks or high grip. Perfect for endurance races



**R+D Team** » Improving Performance



**Procomp 4:** **NEW**  
Highest quality Sponge tyre for smooth race

Rubber tyres for profile hubs.  
Supplied in bags of 2 units with screws

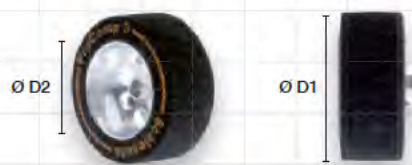

Width	D1 Ø	D2 Ø/Hub Ø	Procomp	Procomp 2	Procomp 3	Procomp 4	Hardcomp
8'0 mm	22'5 mm	17'0 mm					SC-2718p
8'0 mm	23'5 mm	19'0 mm		SC-2632p			
8'0 mm	24'5 mm	19'0 mm					SC-2720p
8'0 mm	24'5 mm	21'0 mm					SC-2719p
8'0 mm	25'2 mm	21'0 mm					SC-2710p
8'0 mm	25'5 mm	17'0 mm					SC-2701p
8'0 mm	23'5 mm	19'0 mm					SC-2722p
8'0 mm	25'5 mm	19'0 mm					SC-2721p
8'0 mm	25'5 mm	21'0 mm		SC-2706p	SC-2708p		SC-2702p
8'0 mm	26'5 mm	21'0 mm					SC-2715p
8'0 mm	27'5 mm	21'0 mm					SC-2709p
11'0 mm	20'5 mm	11'0 mm	SC-2010	SC-2011			
11'0 mm	20'5 mm	15'0 mm	SC-2005	SC-2013	SC-2014		SC-2713p
11'0 mm	22'5 mm	15'0 mm	SC-2015	SC-2016			SC-2714p
11'0 mm	25'5 mm	17'0 mm	SC-2109p	SC-2609p	SC-2409p		
11'0 mm	25'5 mm	21'0 mm	SC-2119p	SC-2619p	SC-2419p		
13'0 mm	23'5 mm	15'0 mm				SC-2404p	
13'0 mm	23'5 mm	17'0 mm					SC-2712p
13'0 mm	24'5 mm	17'0 mm				SC-2405p	
13'0 mm	24'5 mm	19'0 mm		SC-2634p			SC-2534p
13'0 mm	25'0 mm	17'0 mm				SC-2406p	
13'0 mm	25'5 mm	17'0 mm	SC-2110p	SC-2610p	SC-2410p		
13'0 mm	25'5 mm	19'0 mm		SC-2636p	SC-2436p		
13'0 mm	25'5 mm	21'0 mm		SC-2620p	SC-2420p	SC-2520p	
13'0 mm	26'5 mm	21'0 mm	SC-2125p		SC-2425p	SC-2525p	
13'0 mm	26'7 mm	17'0 mm				SC-2407p	
13'0 mm	27'5 mm	17'0 mm				SC-2411p	
13'0 mm	27'5 mm	21'0 mm	SC-2121p	SC-2621p	SC-2421p	SC-2521p	





Width	D1 Ø	D2 Ø/Hub Ø	Procomp	Procomp 2	Procomp 3	Procomp 4	Hardcomp
16'0 mm	24'5 mm	19'0 mm					SC-2537p
16'0 mm	25'5 mm	17'0 mm	SC-2114p	SC-2614p	SC-2414p		
16'0 mm	25'5 mm	19'0 mm					SC-2538p
16'0 mm	25'5 mm	21'0 mm					SC-2515p
16'0 mm	26'5 mm	21'0 mm					SC-2516p
16'0 mm	27'5 mm	21'0 mm	SC-2124p	SC-2624p	SC-2424p		
18'0 mm	25'5 mm	17'0 mm	SC-2112p	SC-2612p	SC-2412p		
18'0 mm	27'5 mm	17'0 mm					SC-2413p
18'0 mm	27'5 mm	21'0 mm		SC-2623p			

**BRM**



Width	D1 Ø	D2 Ø / Hub Ø	Procomp	Procomp 2	Procomp 3	Hardcomp
16 mm	28 mm	21'2 mm Solid				SC-2426brm

**Black edition series**



Width	D1 Ø	D2 Ø / Hub Ø	Procomp	Procomp 2	Procomp 3	Hardcomp
13'0 mm	25'5 mm	21'0 Lightweight		SC-2620pb		

**3/32" Axle**



Width	D1 Ø	D2 Ø / Hub Ø	Procomp	Procomp 2	Procomp 3	Hardcomp
20'0 mm	20'5 mm	11'0 mm	SC-2231			

**1/8" Axle**



Width	D1 Ø	D2 Ø / Hub Ø	Procomp	Procomp 2	Procomp 3	Hardcomp
20'0 mm	20'5 mm	11'0 mm	SC-2321			

**3/32" Axle**



Width	D1 Ø	D2 Ø / Hub Ø	Procomp	Procomp 2	Procomp 3	Hardcomp
9	20'5	15'0				SC-2717p
9	19'0	15'0				SC-2019
9	20'5	15'0				SC-2018
11	20'5	15'0	SC-2007	SC-2008	SC-2009	

**2'5 Axle**



Width	D1 Ø	D2 Ø / Hub Ø	Procomp	Procomp 2	Procomp 3	Hardcomp
11	20'5	11'0	SC-2002			



SC-5040 Tyre truing machine

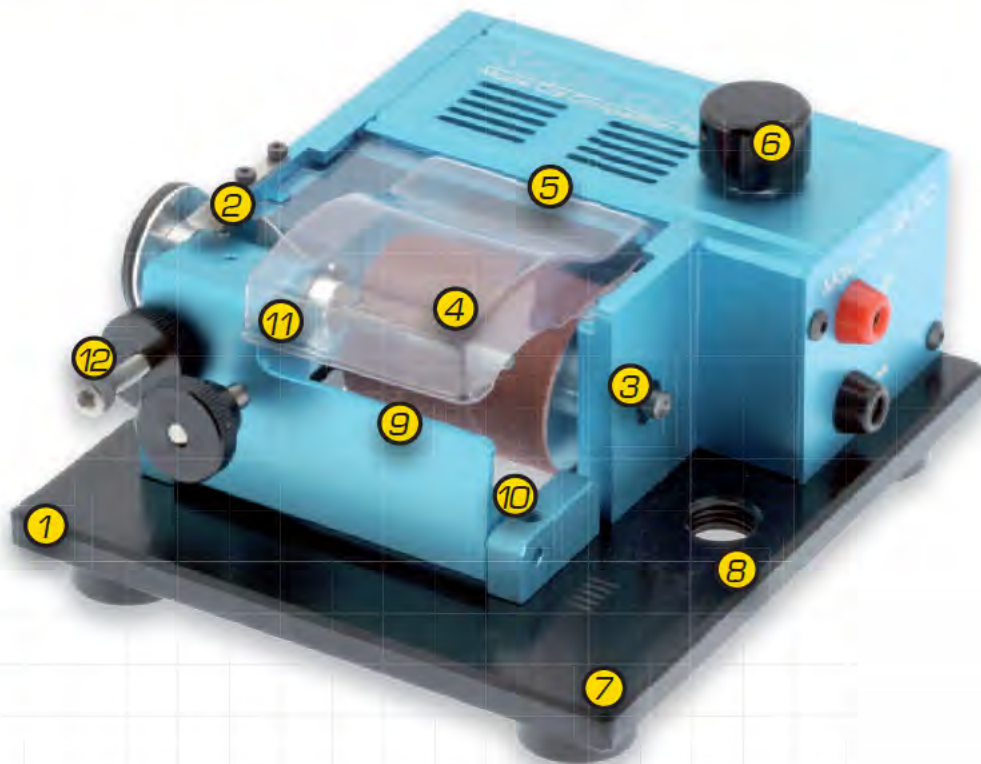
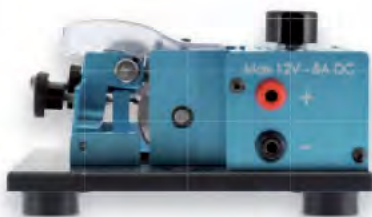

1. Complete vacuum box for dirt storage and protection.
2. Optical sanding measure view.
3. High quality ball bearings.
4. Allow to do 1 or 2 tyres at the same time for a perfect pair of competition set of tyres. Easy to exchange drum with different grain abrasive rolls.
5. Smooth 5 pole motor.
6. Preassembled electronic speed regulator. Only needs 3 Amp to work.
7. Anodized Aluminium CNC machined design.
8. Vacuum Cleaner Fixing Hole.
9. Up to 30 mm diameter tyres allowed.
10. Easy to disassemble for adjusting and replacing sanding drums, belts and cleaning.
11. For all types of available axles (3mm, 3/32" and 2'5mm).
12. Maximum sanding stopper.



SC-5040f Vacuum connector



SC-5040G Aluminium core drum



Reference	Description
SC-5040b	Abrasive roll 80 grid
SC-5040c	Abrasive roll 120 grid
SC-5040d	Abrasive roll 150 grid
SC-5040e	Abrasive roll 180 grid
SC-5040h	Abrasive roll 400 grid

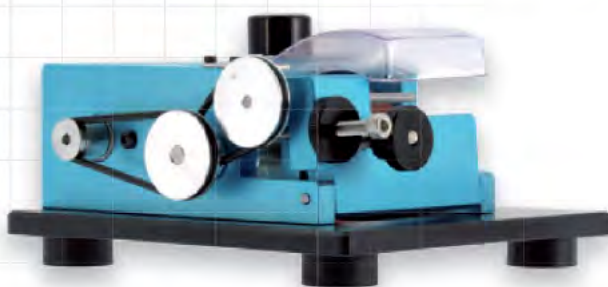
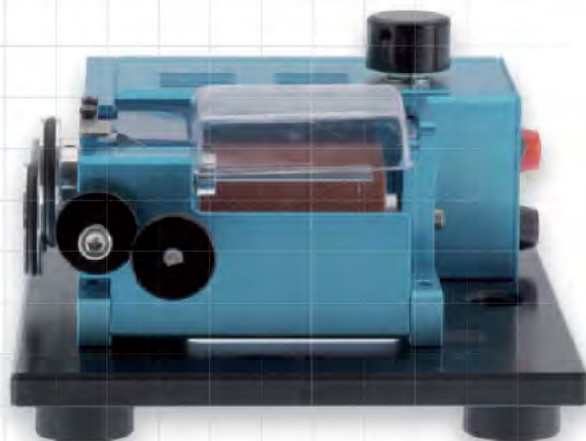



## Chassis ground clearance tools

Reference	Description
SC-5003	Tech tool for chassis ground clearance 1mm
SC-5004	Tech tool for chassis ground clearance 1'3mm
SC-5005	Tech tool for chassis ground clearance 2mm
SC-5006	Tech tool for chassis ground clearance 1mm / 1'2 mm
SC-5005	Tech tool for chassis ground clearance 1'3mm / 1'5mm



SC-5043 Ground clearance tech tool

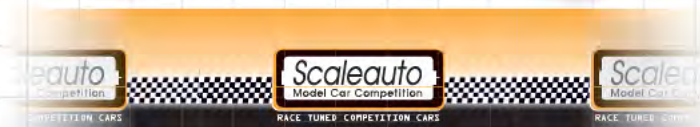

SC-MK001 Scaleauto textile banners for track cover. 0'8 m height. Sold in 50 m rolls

## Acrylic car shelves



SC-5056  
1/32 acrylic car shelf for 2 cars

SC-5057  
1/24 acrylic car shelf for 2 cars



SC-5058  
Extension base for 4 cars for 1/32

SC-5061  
Extension base for 4 cars for 1/24



SC-5059  
Extension base for 6 cars for 1/32

SC-5062  
Extension base for 6 cars for 1/24



SC-5060  
Extension base for 8 cars for 1/32

SC-5063  
Extension base for 8 cars for 1/24

## Specially designed for professional races

1. Convenient transportation platforms for race organization and as storage solution.
2. Keeps your car tyres away from dirt and avoids direct hand manipulation.
3. Expandable from two to eight lanes.
4. Available in two sizes: for 1/32 and 1/24 scale cars.





**SC-5050**

Aluminium modular Slot Box (37x25x80 cm) with wheels

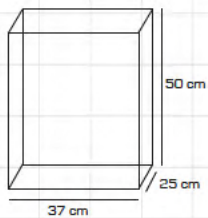
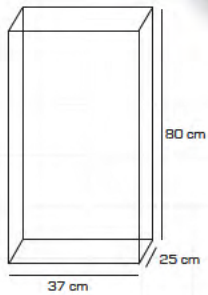

**SC-5051**

Aluminium reduced size Slot Box (37x25x50 cm).

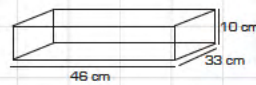

**SC-5052**

Aluminium mini size Slot Box (46x33x10 cm).

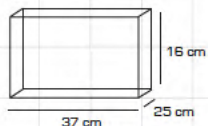

**SC-5053**

Aluminium Slot Box car transport (37x25x16cm).

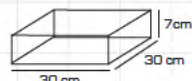

**SC-5054**

Aluminium controller box (30x30x7cm).





Use it to store your bolts, nuts, tires, braids and other small pieces. Join them together to get a larger set of independent storage boxes to fit your needs.

Reference	Description
SC-5055a	Large box container 70x70mm (4 pieces)
SC-5055b	Medium box container, 70x30mm (6 pieces)
SC-5055c	Small box container, 21x30mm (10 pieces)
SC-5055d	Combikit container, 3 sizes containers, fully combinable to store all your spare parts correctly (2 x SC-5055a + 2 x SC-5055b + 6 x SC-5055c)

Tools	ProTool	ProDyno
	SC-5030 ProTool allen 0'95 mm with blue aluminium handle	SC-5044 ProDyno wrench allen 0'95 mm
	SC-5038 ProTool Allen 1'3 mm with blue aluminium handle	SC-5045 ProDyno wrench allen 1'3 mm
	SC-5031 ProTool allen 1'5 mm with blue aluminium handle	SC-5046 ProDyno wrench allen 1'5 mm
	SC-5032 ProTool allen 2 mm with blue aluminium handle	
	SC-5033 ProTool Phillips screwdriver with blue aluminium handle	
	SC-5034 ProTool M4 nut with blue aluminium handle	
	SC-5035 ProTool M4'5 nut with blue aluminium handle	



Adjustable torque  
**ProDyno**



**Basic Tool**

- SC-5024 M1'5 basic allen
- SC-5025 M2'5 basic allen
- SC-5026 M0'95 basic allen



SC-5000b  
Pinion press for all can motors

**ProTool spare bits**

- SC-5036 M1'5 allen bit spare for Pro Tool
- SC-5037 M0'95 allen bit spare for Pro Tool
- SC-5041 M1'3 allen bit spare for Pro Tool
- SC-5079 Flat screw driver
- SC-5047 M0.95 allen bit spare for Pro Tool
- SC-5048 M1'3 allen bit spare for Pro Tool
- SC-5049 M1'5 allen bit spare for Pro Tool



SC-5001b  
Mini pinion puller

- SC-5080 **NEW** Roamer for 2mm, 3/32" and 3mm





# Supporting Race Activities Worldwide



24h race WES 1/24 Igualada 2012



24h race WES 1/32 Barcelona 2012



Tim Comarca 2012



Send us your pictures and the best ones will be published in 2014 catalog

Find more at [www.scaleauto-slot.com](http://www.scaleauto-slot.com)

**IBB** | Auto Racing

IBB Auto Racing, S.L.  
C/ La Masia, 28  
08711 Odena (Barcelona) -Spain-  
Tel. +34 93 803 08 80 Fax. +34 93 805 50 57  
email: [info@bbautoracing.com](mailto:info@bbautoracing.com)  
[www.ibbautoracing.com](http://www.ibbautoracing.com)